



Edelstahl-Rostfrei

mit Gleitschliff-Finish

K 9/05/7
Gruppe 7

Edelstahl-Rostfrei
Gleitschliff-Finish

Scharniere, Beschläge,
Holzverbinder,
Winkel und Verbinder,
Konsolen und Halter

High-grade Stainless Steel
surface finishing

Hinges, Fittings, Wood
connecting pieces,
Angles and connectors,
Brackets and supports

Acier inoxydable
 finition de surface

Charnières, Ferrures,
Raccords pour
 constructions en bois,
Équerres et
connecteurs, Consoles
et supports

Inoxidables
tratamiento de superficies

Bisagras, Herrajes,
Uniones para madera,
Escuadras y placas de
conexión, Soportes
y sujetadores

9/2005



Edelstahl-Scharniere

High-grade steel hinges
Antrouille charnières
Bisagras de acero fino e inoxidable



Gerollte schmale Edelstahl-scharniere

mit vernietetem Edelstahlstift

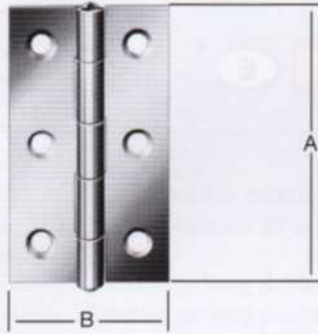

Stck./Karte
SB
2
2
2

Bestell-Nr. lose verpackt	Ausführung	EAN-Nr. 4003984	Abmessungen mm			ca. kg ./. Stck.	Schrauben		verp. zu... Stck.
			A	B	Stärke		Stck.	Ø mm	
010501 030	Rostfrei Werkstoff-Nr. 1.4301	020107	30	22	0,9	0,8	4	2,5	50
010501 040		020114	40	26	0,9	1,2	4	2,5	50
010501 050		020121	50	31	1,0	2,1	6	3	20
010501 060		020145	60	34	1,2	3,0	6	3	10
010501 080		020152	80	41	1,5	5,4	6	3,5	10
010501 100		020169	100	52	1,5	8,8	8	4	10
092028 000	Rostfrei Werkstoff-Nr. 1.4301	510332	40	26	0,9	1,2	4	2,5	5
092029 000		510349	50	31	1,0	2,1	6	3	5
092030 000		510356	60	34	1,2	3,0	6	3	5

Gerollte halbbreite Edelstahl-scharniere

mit vernietetem Edelstahlstift

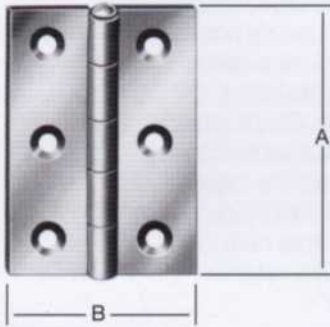

Stck./Karte
SB
2
2
2

010502 040	Rostfrei Werkstoff-Nr. 1.4301	020176	40	32	0,9	1,4	4	2,5	50
010502 050		020183	50	39	1,0	2,6	6	3	20
010502 060		020190	60	46	1,2	4,1	6	3	20
010502 080		020213	80	58	1,5	7,3	6	3,5	20
010502 100		020220	100	72	1,5	12,0	8	4,5	20

Gerollte kältige Edelstahl-scharniere

mit vernietetem Edelstahlstift

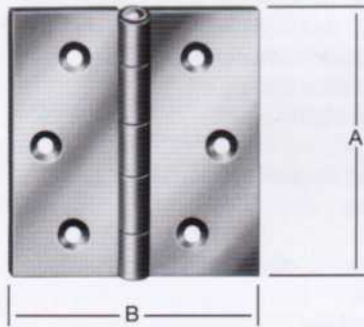

Stck./Karte
SB
2
2
2

010503 030	Rostfrei Werkstoff-Nr. 1.4301	020237	30	30	0,8	1,3	4	2,5	50
010503 040		020244	40	40	0,9	1,8	4	2,5	50
010503 050		020268	50	50	1,0	3,4	6	3	20
010503 060		020275	60	60	1,25	4,6	6	3	10
010503 070		020282	70	70	1,25	5,8	6	3,5	10
010503 080		020299	80	80	1,5	9,8	6	3,5	10
010503 100		020305	100	100	1,5	15,0	8	4	10
092033 000		Rostfrei Werkstoff-Nr. 1.4301	510387	40	40	0,9	1,8	4	2,5
092034 000	510394		50	50	1,0	3,4	6	3	5
092035 000	510400		60	60	1,25	4,6	6	3	5

Gerollte breite Edelstahl-scharniere

mit vernietetem Edelstahlstift

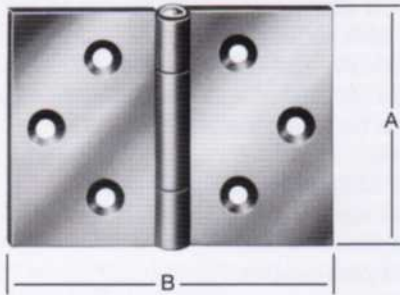

Gerollte breite Edelstahl-Tischbänder

mit vernietetem Edelstahlstift

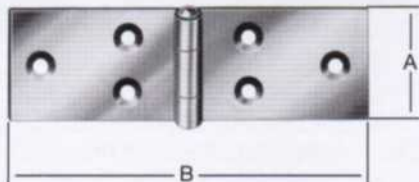



Stck./Karte
SB
2

010504 030	Rostfrei Werkstoff-Nr. 1.4301	020312	30	45	1,0	1,4	6	3	50
010504 040		020329	40	60	0,9	2,4	6	3	20
010504 050		020336	50	75	1,2	4,5	8	3,5	10
010504 060		020343	60	90	1,2	6,6	8	3,5	10
010504 080		020367	80	120	1,5	14,0	8	4	10

010505 080	Rostfrei Werkstoff-Nr. 1.4301	020374	28	80	1,0	2,7	6	3	10
010505 100		020381	32	100	1,2	3,7	6	3	10
010505 120		020404	33	120	1,2	4,6	8	3,5	10
010505 140		020411	34	140	1,5	6,5	8	3,5	10
010505 160		020428	37	160	1,5	8,3	8	3,5	10
092004 000		Rostfrei Werkstoff-Nr. 1.4301	510301	32	100	1,2	3,7	6	3

Bestell-Nr. lose verpackt	Ausführung	EAN-Nr. 4003984	Abmessungen mm			ca. kg ./. Stck.	Schrauben		verp. zu... Stck.
			A	B	Stärke		Stck.	Ø mm	

010613 060	 Werkstoff-Nr. 1.4301	020602	60	60	1,5	8,0	6	4,0	24
------------	--	--------	----	----	-----	-----	---	-----	----

010614 060	 Werkstoff-Nr. 1.4301	020435	60	60	1,5	8,0	6	4	24
010614 075		020442	75	75	1,8	12,0	6	4	12
010614 090		020459	90	90	1,8	18,0	6	4,5	12

010617 075	 Werkstoff-Nr. 1.4301	020572	75	75	1,8	12,0	6	4	24
------------	---	--------	----	----	-----	------	---	---	----

010870 075	 Werkstoff-Nr. 1.4301	020497	75	75	2,5	17,0	6	4	2
010870 090		020503	90	85	2,5	21,0	6	4,5	2

010871 090 (links)	 Werkstoff-Nr. 1.4301	020527	90	90	2,5	22,0	6	4	2
010872 090 (rechts)		020541	90	90	2,5	22,0	6	4	2

Starke Edelstahl-Scharniere



Strong high-grade steel hinges
Antrouille Charnières forte
Bisagras fuertes de acero fino e inoxidable

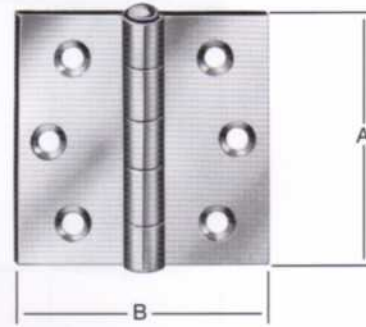

Gerolltes starkes kältiges Edelstahl-Scharnier

mit durchgedrücktem Gewerbe
mit vernietetem Edelstahl-Stift

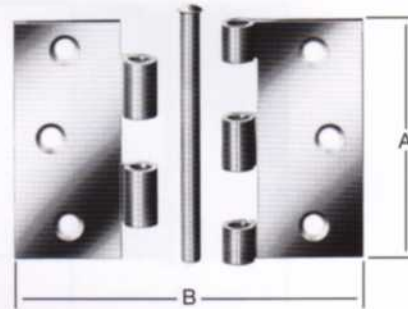

Gerollte starke kältige Edelstahl-Scharniere

mit durchgedrücktem Gewerbe,
mit losem Edelstahl-Knopfstift

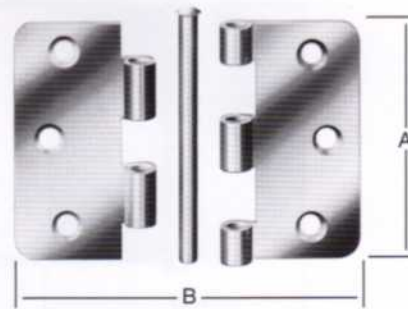

Gerolltes starkes kältiges Edelstahl-Scharnier

mit durchgedrücktem Gewerbe,
mit abgerundeten Ecken (Rad. 10 mm)
mit losem Edelstahl-Knopfstift

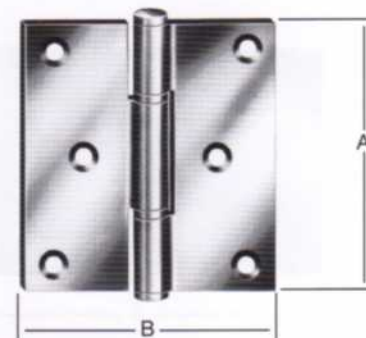

Gerollte Edelstahl-Türscharniere

mit durchgedrücktem Gewerbe,
mit Edelstahl-Zylinder-Stift,
mit Edelstahl-Zwischenringen
Oberfläche trowalisiert

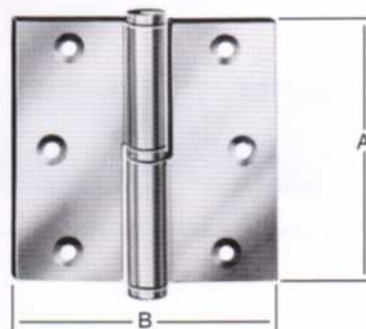

Gerollte aushebbare Edelstahl-Türscharniere

mit durchgedrücktem Gewerbe,
mit Edelstahl-Zylinder-Stift,
und Edelstahl-Zwischenringen
Oberfläche geschliffen



Anschweißbänder

Weld-on hinges
Paumelles à souder
Bisagras para soldar



**Gerolltes
schmales
Edelstahl-
Scharnier**
mit vernietetem
Edelstahlstift

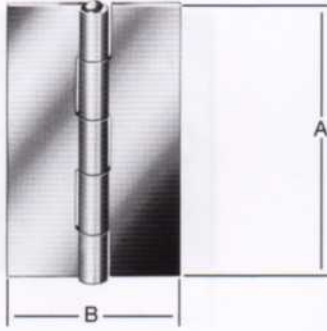

**Gerolltes
halbbreites
Edelstahl-
Scharnier**
mit vernietetem
Edelstahlstift

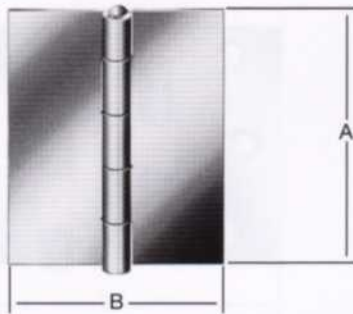

**Gerolltes
kántiges
Edelstahl-
Scharnier**
mit vernietetem
Edelstahlstift

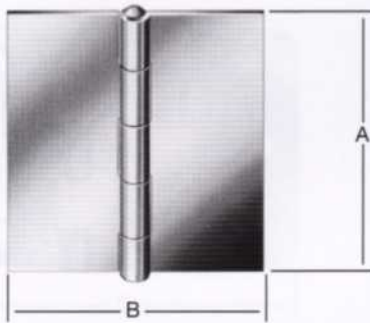

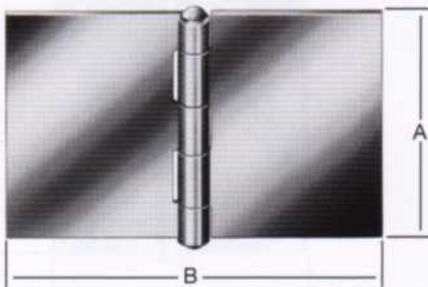

**Gerolltes
breites
Edelstahl-
Scharnier**
mit vernietetem
Edelstahlstift

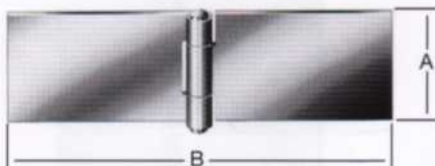

**Gerolltes
breites
Edelstahl-
Tischband**
mit vernietetem
Edelstahlstift



Bestell-Nr. lose verpackt	Ausführung	EAN-Nr. 4003984	Abmessungen mm			ca. kg ./. Stck.	Schrauben		verp. zu... Stck.
			A	B	Stärke		Stck.	Ø mm	
010501 050 U	Werkstoff-Nr. 1.4301	020138	50	31	1,0	2,1	-	-	20
010502 060 U	Werkstoff-Nr. 1.4301	020206	60	46	1,2	4,1	-	-	20
010503 040 U	Werkstoff-Nr. 1.4301	020251	40	40	0,9	1,8	-	-	50
010504 060 U	Werkstoff-Nr. 1.4301	020350	60	90	1,2	6,6	-	-	20
010505 100 U	Werkstoff-Nr. 1.4301	020398	32	100	1,2	3,7	-	-	20

Bestell-Nr. lose verpackt	Ausführung	EAN-Nr. 4003984	Abmessungen mm			ca. kg ./. Stck.	Schrauben		verp. zu... Stck.
			A	B	Stärke		Stck.	Ø mm	
010613 075 U	 Werkstoff-Nr. 1.4301	011372	75	75	1,8	11,9	-	-	24
010614 060 U 010614 075 U	 Werkstoff-Nr. 1.4301	020589 020596	63 75	63 75	1,5 1,8	8,0 12,0	- -	- -	24 24

Gerollte kältige Edelstahl-Scharniere
mit durchgedrücktem Gewerbe
mit vernietetem Edelstahlstift

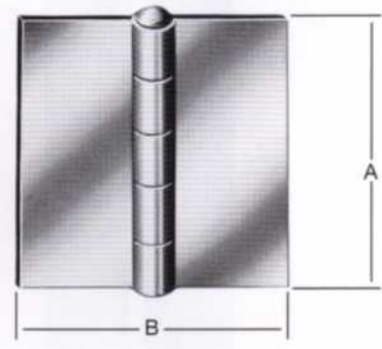

mit losem Edelstahlknopfstift



010870 090 U	 Werkstoff-Nr. 1.4301	020510	90	85	2,5	21,0	-	-	10
--------------	--	--------	----	----	-----	------	---	---	----

Gerolltes Edelstahl-Türscharnier
mit durchgedrücktem Gewerbe

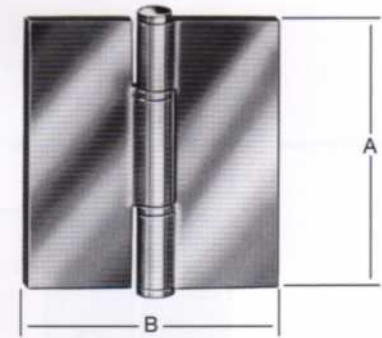

mit festem **Edelstahl-Zylinder-Stift** und Edelstahl-Zwischenringen
Oberfläche trowallisiert



011001 080	 Werkstoff-Nr. 1.4301	020565	80	16	Ø 13,0	9,5	-	-	24
------------	--	--------	----	----	-----------	-----	---	---	----

Profil-Edelstahl-Bandrolle
Oberfläche blank



Stangen-/Möbelscharniere

Piano hinges
Charnières de piano
Bisagras de piano



Ungebohrte Edelstahl- Stangen- scharniere

ähnlich DIN 7956
(Haubenscharniere)

Oberfläche walzblank



Ungebohrte starke Edelstahl- Stangen- scharniere

(Haubenscharniere)

Oberfläche walzblank

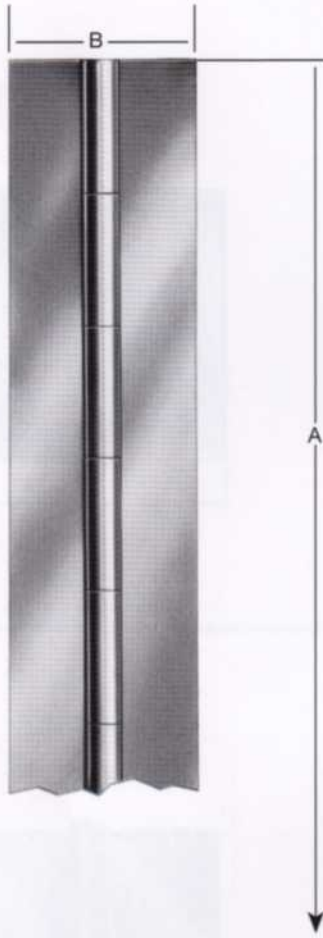

Bestell-Nr. lose verpackt	Ausführung	EAN-Nr. 4003984	Abmessungen mm			Ø Stift	Schrauben		verp. zu... Stck.
			A	B	Stärke		Stck.	Ø mm	
010450 032 U	Rostfrei Werkstoff-Nr. 1.4301	020022	3500	32	0,7	1,7	-	-	10
010450 321 U		020046	3500	32	1,0	1,7	-	-	10

010460 003	Rostfrei Werkstoff-Nr. 1.4301	020053	3500	32	1,5	3,0	-	-	5
010460 004		020060	3500	40	1,5	3,0	-	-	5
010460 005		020077	3500	50	1,5	3,0	-	-	5
010460 050		020084	3500	50	2,0	6,0	-	-	5
010460 060		020091	3500	60	2,0	6,0	-	-	5

Edelstahl- Stangen- scharniere

ähnlich DIN 7956

Oberfläche walzblank

Stck./Karte
1
1
1

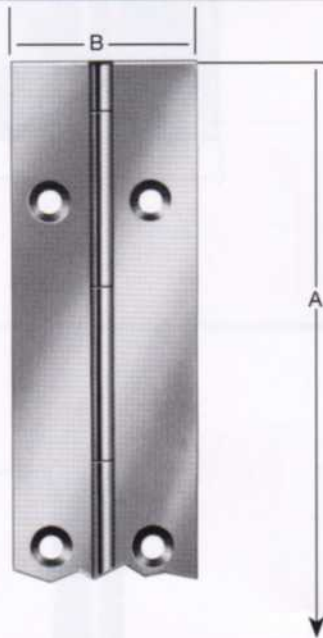

010450 032	Rostfrei Werkstoff-Nr. 1.4301	020015	3500	32	0,7	1,7	-	2,5	10
010450 040		020039	3500	40	0,7	1,7	-	2,5	10

092541 000	Rostfrei Werkstoff-Nr. 1.4301	510509	600	32	0,7	1,7	20	2,5	10
092542 000		510516	900	32	0,7	1,7	30	2,5	10
092543 000		510523	1200	32	0,7	1,7	40	2,5	10

Gerollte Edelstahl- Möbel- scharniere

aushebbar, gerade,
mit durchgedrücktem
Gewerbe
(Abb. ist links)

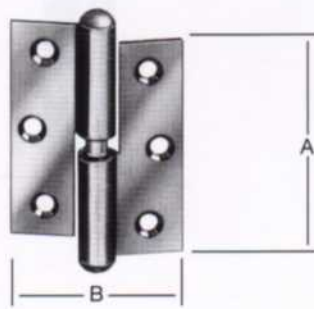

010620 050	Rostfrei Werkstoff-Nr. 1.4301	020466	50	40	1,5	3,9	6	3	20
010620 051		020473	50	40	1,5	3,9	6	3	20

Bestell-Nr. lose verpackt	Ausführung	EAN-Nr. 4003984	Abmessungen mm			ca. kg ./. Stck.	Schrauben		verp. zu... Stck.
			A A ₁ A ₂	B	Stärke		Stck.	Ø mm	

Sonstige Scharniere und Bänder



Other hinges
Autres charnières
Otras bisagras

010043 035	 Werkstoff-Nr. 1.4301	180559	35 20	40	1,5	3,2	5	3	20
------------	-----------------------------	--------	----------	----	-----	-----	---	---	----

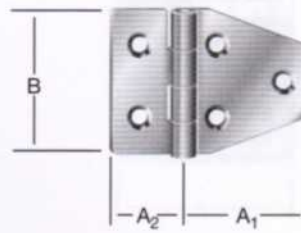

Gerolltes Edelstahl- Band

mit **Edelstahlstift**
und versenkten
Schraublöchern



010046 070	 Werkstoff-Nr. 1.4301	180542	70	40	1,5	3,5	6	3	20
------------	-----------------------------	--------	----	----	-----	-----	---	---	----

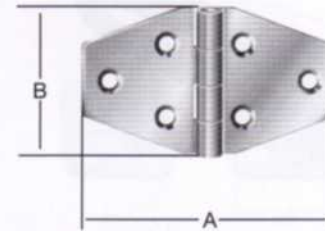

Gerolltes Edelstahl- Band

mit **Edelstahlstift**
und versenkten
Schraublöchern



010043 080	 Werkstoff-Nr. 1.4301	180054	80 30	37	1,5	4,5	6	4	20
------------	-----------------------------	--------	----------	----	-----	-----	---	---	----

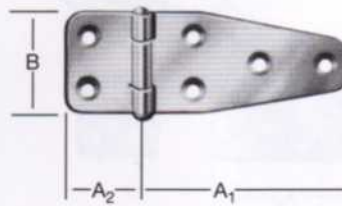

Gerolltes Edelstahl- Band

mit **vernietetem
Edelstahlstift**
mit versenkten
Schraublöchern



010046 160	 Werkstoff-Nr. 1.4301	180061	160	37	1,5	6,0	8	4	20
------------	-----------------------------	--------	-----	----	-----	-----	---	---	----

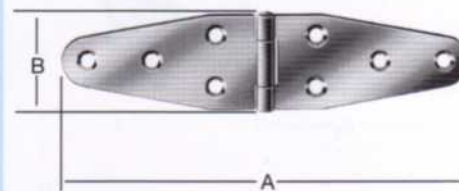

Gerolltes Edelstahl- Band

mit **vernietetem
Edelstahlstift**
mit versenkten
Schraublöchern



010028 160 010028 200	 Werkstoff-Nr. 1.4301	020619 020626	160 200	35 35	2 2	12,0 15,0	8 8	4 4	10 10
--------------------------	-----------------------------	------------------	------------	----------	--------	--------------	--------	--------	----------

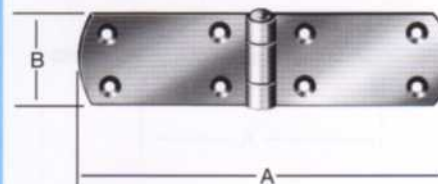

Gerollte Edelstahl- Kistenbänder

mit **vernietetem
Edelstahlstift**,
mit versenkten
Schraublöchern



010096 200	 Werkstoff-Nr. 1.4301	180092	200	35	2	15,0	4	5	5
------------	-----------------------------	--------	-----	----	---	------	---	---	---



Gerolltes Edelstahl- Kistenband

mit versenkten
Schraublöchern
und mit **vernietetem
Edelstahlstift**



Überfallen

Padlock latch with eyelet plates
Morillons avec plaques
Pestillos con placas con ojete



Ösenplatte

passend zu Art.-Nr.
010090.../010092...

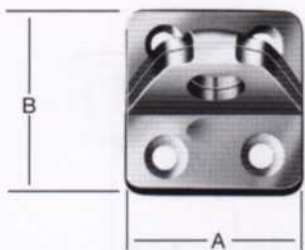

Bestell-Nr. lose verpackt	Ausführung	EAN-Nr. 4003984	Abmessungen mm			ca. kg ./. Stck.	Schrauben		verp. zu... Stck.
			A A ₁ A ₂	B	Stärke		Stck.	Ø mm	
010075 035	 Werkstoff-Nr. 1.4301	180351	35	35	2,0 Ösen- Ø 11	4,5	4	3,5	20

Gerollte Edelstahl- Überfallen

mit angebundener
Ösenplatte

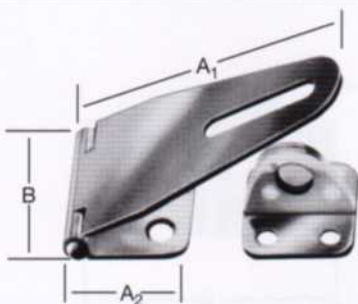

Stck./Karte
1



010090 080	 Werkstoff-Nr. 1.4301	180078	80 30	37	1,5	7,0	2 4	4,0 3,5	5
091977 000	 Werkstoff-Nr. 1.4301	510240	80 30	37	1,5	7,0	2 4	4,0 3,5	5

Edelstahl- Sicherheits- Überfalle

mit angebundener
Ösenplatte
(Ösen Ø 11 mm)

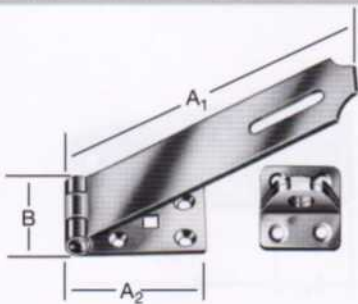

010021 145	 Werkstoff-Nr. 1.4301	180580	100 45	35	2,75	18,0	8 rd. 1 □	4,5 6	5
------------	-----------------------------	--------	-----------	----	------	------	--------------	----------	---

Edelstahl- Überfalle

mit angebundener
Ösenplatte

mit versenkten
Schraublöchern
und mit vernietetem
Edelstahlstift
(Ösen Ø 11 mm)

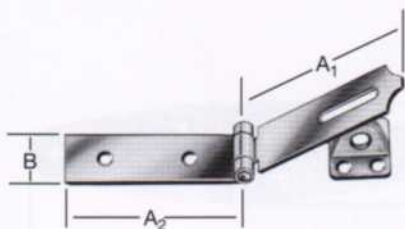

010092 200	 Werkstoff-Nr. 1.4301	180085	100 100	35	2	13,0	2 4	4,5 3,5	5
------------	-----------------------------	--------	------------	----	---	------	--------	------------	---

Edelstahl- Sturmhaken

mit
angebundener Öse

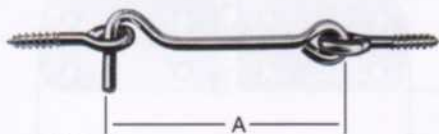

010082 080	 Werkstoff-Nr. 1.4301	180658	80	-	Ø 3,9	1,6	-	-	20
010082 120		180665	120	-	4,2	3,0	-	-	20

Grendelriegel mit Schlaufe

Stck./Karte
1



091948 000	 Werkstoff-Nr. 1.4301	510158	55	35	1,25	7,3	6	3,0	5
------------	-----------------------------	--------	----	----	------	-----	---	-----	---

Überfallen

Padlock latch with eyelet plates
Morillons avec plaques
Pestillos con placas con ojete



Ösenplatte

passend zu Art.-Nr.
010090.../010092...

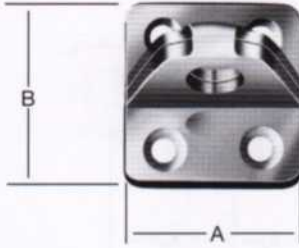

Bestell-Nr. lose verpackt	Ausführung	EAN-Nr. 4003984	Abmessungen mm			ca. kg ./. Stck.	Schrauben		verp. zu... Stck.
			A A ₁ A ₂	B	Stärke		Stck.	Ø mm	
010075 035	 Werkstoff-Nr. 1.4301	180351	35	35	2,0 Ösen- Ø 11	4,5	4	3,5	20

Gerollte Edelstahl- Überfallen

mit angebundener
Ösenplatte

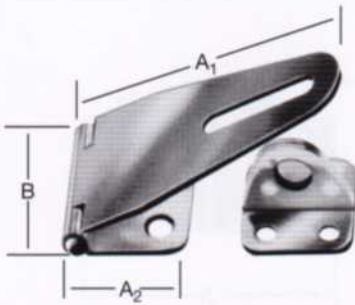

Stck./Karte
1



010090 080	 Werkstoff-Nr. 1.4301	180078	80 30	37	1,5	7,0	2 4	4,0 3,5	5
091977 000	 Werkstoff-Nr. 1.4301	510240	80 30	37	1,5	7,0	2 4	4,0 3,5	5

Edelstahl- Sicherheits- Überfalle

mit angebundener
Ösenplatte
(Ösen Ø 11 mm)

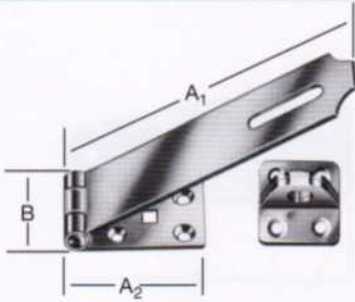

010021 145	 Werkstoff-Nr. 1.4301	180580	100 45	35	2,75	18,0	8 rd. 1 □	4,5 6	5
------------	-----------------------------	--------	-----------	----	------	------	--------------	----------	---

Edelstahl- Überfalle

mit angebundener
Ösenplatte

mit versenkten
Schraublöchern
und mit vernietetem
Edelstahlstift
(Ösen Ø 11 mm)

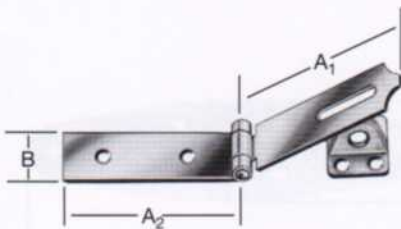

010092 200	 Werkstoff-Nr. 1.4301	180085	100 100	35	2	13,0	2 4	4,5 3,5	5
------------	-----------------------------	--------	------------	----	---	------	--------	------------	---

Edelstahl- Sturmhaken

mit
angebundener Öse

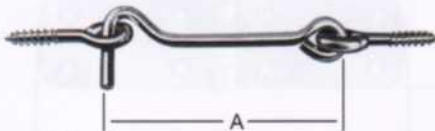

010082 080	 Werkstoff-Nr. 1.4301	180658	80	-	Ø 3,9	1,6	-	-	20
010082 120		180665	120	-	4,2	3,0	-	-	20

Grendelriegel

mit Schlaufe

Stck./Karte
1



091948 000	 Werkstoff-Nr. 1.4301	510158	55	35	1,25	7,3	6	3,0	5
------------	-----------------------------	--------	----	----	------	-----	---	-----	---

Bestell-Nr. lose verpackt	Ausführung	EAN-Nr. 4003984	Abmessungen mm			ca. kg ./. Stck.	Schrauben		verp. zu... Stck.
			A A ₁ A ₂	B	Stärke		Stck.	Ø mm	
010102 080 010102 100	Rost frei Werk- stoff-Nr. 1.4301	180429	80	30	1,0	5,5	7	2,5	10
		180467	100	35	1,0	8,2	7	2,5	5
091946 000	Rost frei Werk- stoff-Nr. 1.4301	510615	80	30	1,0	5,5	7	2,5	5

Riegel und Schlaufen



Bolts and bolt loops
Verrous et Gâches
Cerrojos y Argollas para cerrojos

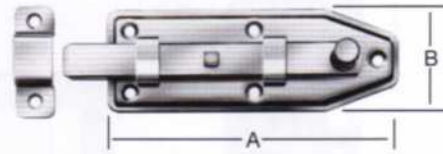

**Edelstahl-
Fensterriegel**
mit angebundener
Schlaufe
gerade

Stck./Karte
1



010105 120 010105 140	Rost frei Werk- stoff-Nr. 1.4301	180436	120	56	1,75	17,0	7	4,0	5
		180474	140	56	1,75	26,0	7	4,0	5

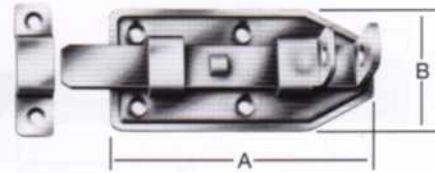

**Edelstahl-
Türschloss-
riegel**
mit angebundener
Schlaufe
gerade

010107 120 010107 140	Rost frei Werk- stoff-Nr. 1.4301	180450	120	56	1,75	17,0	6	4,0	5
		180481	140	56	1,75	26,0	7	4,0	5

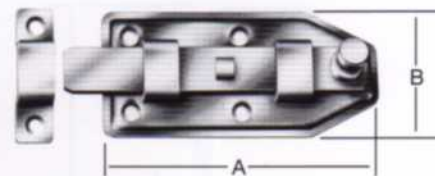

**Edelstahl-
Türkno-
pfriegel**
mit angebundener
Schlaufe
gerade

010104 130	Rost frei Werk- stoff-Nr. 1.4301	600682	130 40	43,5	2,2	32,0	2 rd. 6 □	4,5 5,0	2
------------	--	--------	-----------	------	-----	------	--------------	------------	---

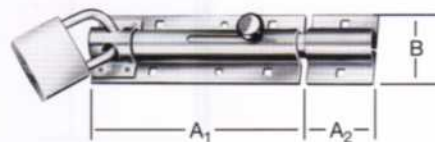

**Edelstahl-
Bolzen-
Türschloss-
riegel**
mit angebundener
Schlaufe
Bolzen Ø 12 mm

Oberfläche walzblank

010227 080	Rost frei Werk- stoff-Nr. 1.4301	600699	80	36	1/2	10,4	6	3,5	2
------------	--	--------	----	----	-----	------	---	-----	---

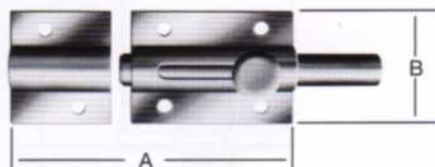

**Edelstahl-
Bolzen-
Knopfriegel**
mit angebundener
Schlaufe
Bolzen Ø 10 mm

Oberfläche walzblank

010222 080	Rost frei Werk- stoff-Nr. 1.4301	180535	80 100	22	1,0	4,0	6	2,5	10
------------	--	--------	-----------	----	-----	-----	---	-----	----

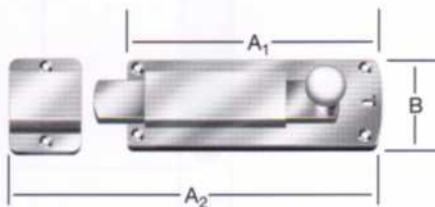

**Edelstahl-
Deco-
Knopfriegel**
mit angebundener
Schlaufe

Torbeschlage

Gate fittings
Ferrures pour portes
Herrajes para puertas



Edelstahl-Gartentorfaller Typ 1

mit angebundenem Klinkhaken, rechts und links verwendbar

Verstellbereich 40 mm

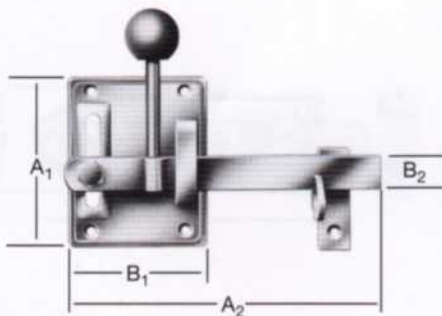

Bestell-Nr. lose verpackt	Ausfuhrung	EAN-Nr. 4003984	Abmessungen mm			ca. kg ./. Stck.	Schrauben		verp. zu... Stck.
			A A ₁ A ₂	B B ₁ B ₂	Starke		Stck.	Ø mm	
010085 000	 Werkstoff-Nr. 1.4301	510608	100 165	80 20	2 5	50,0	4 2	4,5 5	1

Edelstahl-Doppeltor-uberwurf

rechts und links verwendbar

Bolzen doppelt gelagert

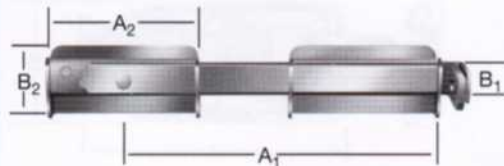

010084 000	 Werkstoff-Nr. 1.4301	180634	250 115	25 55	2	73,0	8	6	1
------------	-----------------------------	--------	------------	----------	---	------	---	---	---

Edelstahl-Bodenschieber

mit 2 Fuhrungswinkeln

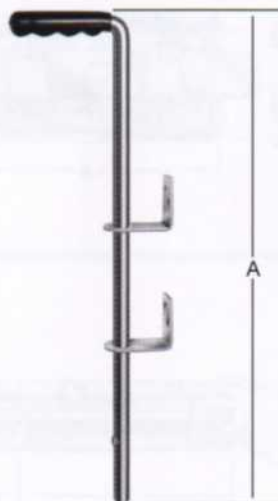

010088 001	 Werkstoff-Nr. 1.4301	180627	500	-	Ø16	80,0	-	-	1
------------	-----------------------------	--------	-----	---	-----	------	---	---	---

Leichte Edelstahl-Kreuzgehange

(Verbands-Nr. 124)

matt kugelgestrahlt

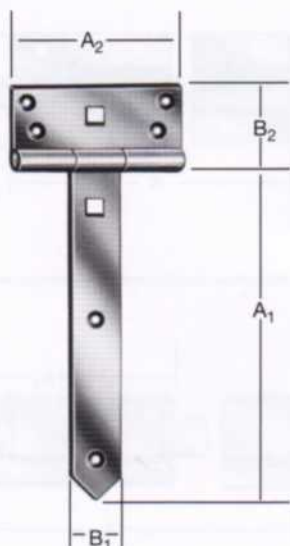

010124 200	 Werkstoff-Nr. 1.4301	180566	200	33	3	30,0	2 □	8,0	1
010124 300		180573	90	50	3	40,0	6 rd.	5,0	
			300	33	3			2 □	8,0
			90	50			7 rd.	5,0	
							□		

Bestell-Nr. lose verpackt	Ausführung	EAN-Nr. 4003984	Abmessungen mm			ca. kg ./. Stck.	Schrauben		verp. zu... Stck.
			A A ₁ A ₂	B B ₁ B ₂	C		Stck.	Ø mm	
010072 013	 Werkstoff-Nr. 1.4301	180498	13	140	12	18,0	-	-	1

Kloben und Ladenbänder

Pulley-block/Hooks and Shutter hinges
Gonds/Crochets et Paumelles de volets
Goznes/Ganchos y Bisagras de ramal para postigos

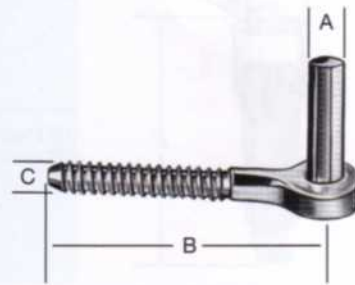

**Edelstahl-
„J“-Kloben**
zum Einschrauben
mit angeschnittenem
Gewinde

mattiert
kugelgestrahlt

010073 013	 Werkstoff-Nr. 1.4301	180504	13	100	30	19,0	4	5	1
010073 016		180511	16	120	40	37,0	6	6	1

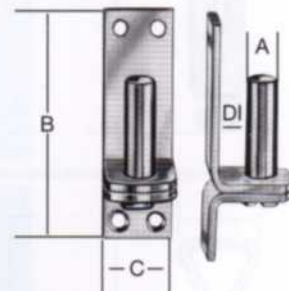

**Edelstahl-
„DI“-Kloben**
auf Platte

Abstand DI = 10 mm

mattiert
kugelgestrahlt

010114 200	 Werkstoff-Nr. 1.4301	180610	200 75	30 35	3 4	30,0	1 rd. 2 rd.	8 5	2
------------	--	--------	-----------	----------	--------	------	----------------	--------	---

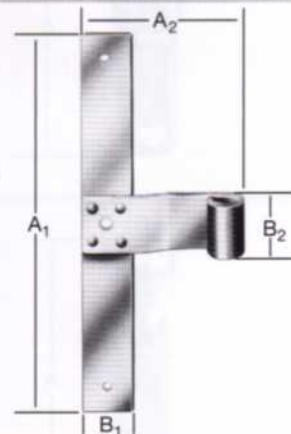

**Edelstahl-
Fensterladen-
Mittelband**

für Dorn-Ø 13 mm
(Verbands.-Nr. 30)

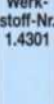
Bestell-Nr. lose verpackt	Ausführung	EAN-Nr. 4003984	Abmessungen mm				ca. kg ./. Stck.	Schrauben		verp. zu... Stck.
			A	B	Dorn- Stärke	Stärke		Stck.	Ø mm	
010066 400		510547	400	40	13	4	53,0	1 □ 3 rd.	9 6	1
010066 500	 Werkstoff-Nr. 1.4301	510554	500	40	13	4	64,0	1 □ 4 rd.	9 6	1
010066 600		510578	600	40	13	4	77,0	1 □ 5 rd.	9 6	1

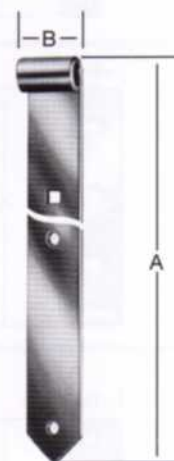

**Halbschwere
Edelstahl-
Ladenbänder**

(Verbands.-Nr. 6)
für Dorn Ø 13 mm

mattiert
kugelgestrahlt

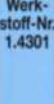
010067 600		510585	600	45	16	5	120,0	1 □ 3 rd.	9 8	1
010067 700	 Werkstoff-Nr. 1.4301	510592	700	45	16	5	130,0	1 □ 4 rd.	9 8	1
010067 800		510561	800	45	16	5	150,0	1 □ 5 rd.	9 8	1

**Schwere
Edelstahl-
Ladenbänder**

(Verbands.-Nr. 8)
für Dorn Ø 16 mm

mattiert
kugelgestrahlt

Spannverschlüsse / Schließhaken

Chest locks / Fastening hooks
Ferroirs de coffres / Fermoirs à crochet
Cierres de caja / Ganchos de cierre



Edelstahl-Spannverschlüsse

DIN 3133
mit Plombiermöglichkeit ohne Schließhaken



mit gekröpften Schließhaken



Bestell-Nr. lose verpackt	Ausführung	EAN-Nr. 4003984	Abmessungen mm		Schrauben		verp. zu... Stck.	Passende Schließhaken DIN-Form G = Nr. 8 DIN-Form K = Nr. 9 G = gerade K = gekröpft	
			A	B	Stck.	Ø mm			
011202 050	Rost-Freel Werkstoff-Nr. 1.4301	180245	55	23	2	3/2,5	20	010008 115	010009 015
011202 070		180252	74	30	2	3/4	20	010008 018	010009 018
011202 105		180269	114	37	3	4	20	010008 025	010009 025
091964 000	Rost-Freel Werkstoff-Nr. 1.4301	510226	55	23	2	3/2,5	5		
091965 000		510233	74	30	2	3/4	5		

Edelstahl-Spannverschluss

mit Schlossöse
DIN 3133
mit Plombiermöglichkeit
ohne Schließhaken



011209 105	Rost-Freel Werkstoff-Nr. 1.4301	180276	109	36	2	4	20	010008 025	010009 025
------------	---------------------------------------	--------	-----	----	---	---	----	------------	------------

Edelstahl-Spannverschluss

mit Schraubverstellung

Verstellbereich
10 - 15 mm

ohne Schließhaken



011203 000	Rost-Freel Werkstoff-Nr. 1.4301	180375	125	33	3	2,0	20	010008 018	010009 018
------------	---------------------------------------	--------	-----	----	---	-----	----	------------	------------

Edelstahl-Spannverschluss

mit Schraubverstellung
Verstellbereich:
10-12mm

ohne Schließhaken

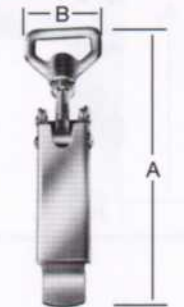

011207 000	Rost-Freel Werkstoff-Nr. 1.4301	103015	170	47	3	5,5	10	-	010009 030
------------	---------------------------------------	--------	-----	----	---	-----	----	---	------------

Gerade Edelstahl-Schließhaken für Spannverschlüsse

DIN 3133
Gerade Form
(Form G)

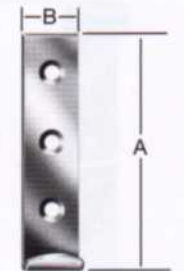

Bestell-Nr. lose verpackt	Ausführung	EAN-Nr. 4003984	Abmessungen mm			ca. kg ./. Stck.	Schrauben		verp. zu... Stck.
			A	B	Stärke		Stck.	Ø mm	
010008 018	Rost-Freel Werkstoff-Nr. 1.4301	180016	44	18	2	1,0	2	3,5	20
010008 025		180412	83	25	2	3,2	3	4,5	20
010008 115		180023	44	15	2	0,5	2	3,5	20

Gekröpfte Edelstahl-Schließhaken für Spannverschlüsse

DIN 3133
Gekröpfte Form
(Form K)

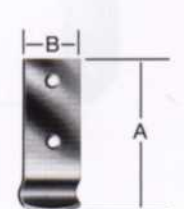

010009 015	Rost-Freel Werkstoff-Nr. 1.4301	180030	46	15	2	0,5	2	3,5	20
010009 018		180047	48	18	2	1,0	2	3,5	20
010009 025		180405	83	25	2	3,2	3	4,5	20
010009 030		180399	107	30	2	5,0	3	5,0	10

Bestell-Nr. lose verpackt	Ausführung	EAN-Nr. 4003984	Abmessungen mm			Griff Ø	ca. kg ./. Stck.	Schrauben		verp. zu... Stck.
			A	B	Stärke			Stck.	Ø mm	
011330 065	 Werkstoff-Nr. 1.4301	180290	65	55	1	-	4,8	4	3	5

Kistenbeschläge



Case fittings
Essayages de boîte
Herrajes de cofres

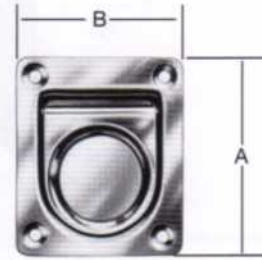

Edelstahl-Einlassgriff

010190 005	 Werkstoff-Nr. 1.4301	180214	170	105	2,0	10	50,0	4	5,0	2
------------	--	--------	-----	-----	-----	----	------	---	-----	---

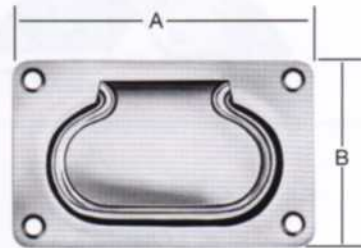

Edelstahl-Einlass-Kistengriff

ähnlich DIN 3135
mit abgerundeten
Ecken

011328 100	 Werkstoff-Nr. 1.4301	170283	100	80	1,5	7,5	18,0	4	4,5	5
------------	---	--------	-----	----	-----	-----	------	---	-----	---

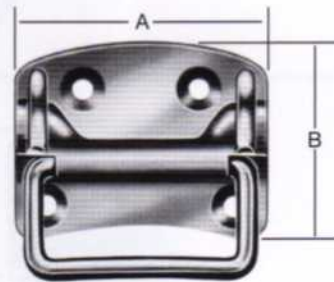

Edelstahl-Kistengriff

DIN 3136

010193 160 010193 200	 Werkstoff-Nr. 1.4301	180313 180320	160 200	20 20	4 4	- -	11,8 14,4	4 4	4,5 4,5	5 10
--------------------------	--	------------------	------------	----------	--------	--------	--------------	--------	------------	---------

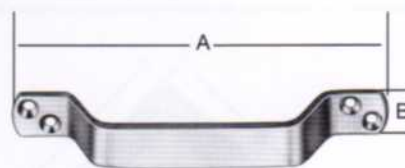

Edelstahl-Handgriffe

010240 036	 Werkstoff-Nr. 1.4301	180238	36	-	0,7	-	2,1	3	3,0	20
------------	--	--------	----	---	-----	---	-----	---	-----	----



Edelstahl-Kistenecke
(Schutzecke)

DIN 7469
hohe Form (A)

010255 000	 Werkstoff-Nr. 1.4301	570114	74	32	1,25	-	2,0 1	1 rd. 16 x 5	5	50
------------	--	--------	----	----	------	---	----------	-----------------	---	----

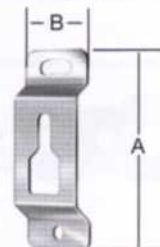

Edelstahl-Aufhänge-lasche

